

## DISCOVER PLANAR STYLE 8

UNIVERSAL AND FLEXIBLE, THE RADIATOR WITH 8 CONNECTION POSSIBILITIES AND A CONSTANT WALL DISTANCE OF 65 MM AT THE CENTRE CONNECTION

## General information

### PLANAR STYLE 8

The Planar Style 8 is with a stylish front, perfectly fitting side panels and upper grille a decorative radiator that creates an atmosphere of light and space. Furthermore you have, thanks to the 4 side- and 4 bottom connections, a variety of connection possibilities. This makes the Planar Style 8 easy to install and applicable in about every situation. In addition, it offers a uniform wall distance of 65 mm for all types at the centre connection.

Product:	decorative valve radiator with a stylish front and 8 connections
Finishing:	decorative stylish front, upper grille and side panels
Pre-installed:	preset valve insert, air vent and blind plugs
Valve insert:	The integrated adjustable valve insert (without thermostatic head) is factory-fit on the right side of the radiator; tested in accordance with EN215 and compatible with thermostatic heads M30 x 1,5 mm. The thermostatic valve insert is factory-set in relation to the size of the radiator. This presetting ensures optimum throughput in the radiator. Factory setting for two-pipe systems, also suitable for one-pipe systems (as long as the valve insert is adjusted to position 8).
Also supplied:	Monclac brackets with anti-lift (VDI compliant when used in combination with included anti-slide clips), screws, plugs and installation instructions
Connections:	4 x ¾" male Eurocone bottom connection (2 x centre and 2 x lateral) and 4 x ½" female side connection. Uniform wall distance of 65 mm for all types at the centre connection.
Lugs:	Type 11 is equipped with 2 pairs of mounting lugs up to 1.600 mm and 3 pairs from 1.800 mm
Packaging:	Every radiator is sturdily packaged in high-quality cardboard and wrapped in plastic. The radiator's characteristics are shown on the label: type – height – length.
Warranty:	10 years, as long as the installation instructions have been followed and Stelrad's warranty conditions have been met.
Paint process:	All radiators are degreased, phosphated, cathodically primed and powder-coated in Stelrad white 9016 as standard.
Colours:	Stelrad white 9016 + 35 different Stelrad colours and about 200 RAL-colours are possible
Max. operating pressure:	10 bar (tested to 13 bar)
Max. operating temperature:	110 °C
Conformity:	in accordance with EN442
Quality assurance:	NF
Types:	11   21   22   33
Heights:	300   400   500   600   700   900 mm
Lengths:	400 – 2.000 mm
Depths:	63   79   102   160 mm



## Type overview

Calculation factor  
per meter  
at 75/65/20°C  
according to EN442

Characteristic equation:

$$\Phi = K_M \times \Delta T^n$$

\* centre connection only

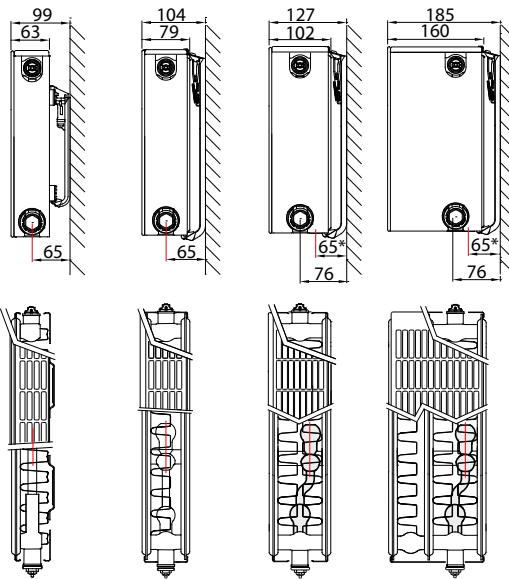

Height		Type 11	Type 21	Type 22	Type 33	Centre distance
300	W			898	1.287	250
	kg			19,30	27,60	
	l			3,10	5,40	
	m <sup>2</sup>			3,51	5,26	
	n			1,30	1,30	
400	W	614	870	1.153	1.649	350
	kg	16,20	22,60	25,67	36,63	
	l	2,30	4,15	4,13	6,63	
	m <sup>2</sup>	2,95	3,37	4,92	7,38	
	n	1,27	1,30	1,30	1,31	
500	W	746	1.038	1.388	1.979	450
	kg	20,23	28,00	32,03	45,67	
	l	2,77	5,20	5,17	7,87	
	m <sup>2</sup>	3,80	4,31	6,33	9,49	
	n	1,28	1,30	1,31	1,32	
600	W	870	1.196	1.601	2.280	550
	kg	24,27	33,60	38,40	54,70	
	l	3,23	6,25	6,20	9,10	
	m <sup>2</sup>	4,66	5,24	7,74	11,61	
	n	1,28	1,31	1,31	1,32	
700	W	987	1.350	1.796	2.553	650
	kg	28,30	39,20	44,70	63,60	
	l	3,70	7,30	7,03	10,63	
	m <sup>2</sup>	5,51	6,18	9,15	13,72	
	n	1,28	1,31	1,32	1,33	
900	W	1.200	1.649	2.132	3.022	850
	kg	35,90	50,60	57,30	81,40	
	l	4,50	9,00	8,70	13,70	
	m <sup>2</sup>	7,22	8,05	11,97	17,96	
	n	1,28	1,32	1,32	1,33	

W=heat output per meter / kg=weight per meter / l=content per meter / m<sup>2</sup>=surface per meter / n=exponent  
The manufacturer reserves the right to alter any of the specifications shown in this document without prior notice.

## PLANAR STYLE 8

Heat outputs in Watt according to EN442



**EN442 (W) 70/50/20°C**

**EN442 (W) 55/45/20°C**

Stelrad BV/PL 19/01/07/E013

Height	300	
Type	22	33
W/m 75/65/20°C	898	1.287
<b>400</b>		
<b>500</b>	336 231 0654032205	482 331 0654033305
<b>600</b>		
<b>700</b>		
<b>800</b>	537 370 0654032208	770 530 0654033308
<b>900</b>	605 416 0654032209	866 596 0654033309
<b>1000</b>	672 463 0654032210	963 662 0654033310
<b>1200</b>	807 555 0654032212	1.155 794 0654033312
<b>1400</b>	941 648 0654032214	1.348 927 0654033314
<b>1600</b>	1.076 740 0654032216	1.540 1.059 0654033316
<b>1800</b>	1.210 833 0654032218	1.733 1.192 0654033318
<b>2000</b>	1.344 925 0654032220	1.925 1.324 0654033320

400			
11	21	22	33
614	870	1.153	1.649
231 160 0653041105	326 224 0654042105	431 296 0654042205	615 422 0654043305
277 192 0653041106	391 269 0654042106	517 356 0654042206	739 507 0654043306
324 224 0653041107	456 314 0654042107	603 415 0654042207	862 592 0654043307
370 256 0653041108	521 359 0654042108	689 474 0654042208	985 676 0654043308
416 289 0653041109	586 404 0654042109	776 533 0654042209	1.108 761 0654043309
462 320 0653041110	652 449 0654042110	862 593 0654042210	1.231 845 0654043310
555 385 0653041112	782 539 0654042112	1.035 711 0654042212	1.478 1.014 0654043312
647 449 0653041114	912 628 0654042114	1.207 829 0654042214	1.724 1.184 0654043314
739 512 0653041116	1.043 718 0654042116	1.379 948 0654042216	1.970 1.352 0654043316
832 577 0653041118	1.173 808 0654042118	1.551 1.066 0654042218	2.217 1.521 0654043318
924 641 0653041120	1.303 898 0654042120	1.724 1.185 0654042220	2.463 1.690 0654043320

500			
11	21	22	33
746	1.038	1.388	1.979
224 155 0653051104	310 213 0654052104	414 284 0654052204	591 405 0654053304
281 194 0653051105	388 267 0654052105	518 356 0654052205	738 506 0654053305
337 234 0653051106	466 320 0654052106	622 427 0654052206	885 606 0654053306
393 272 0653051107	544 374 0654052107	726 498 0654052207	1.033 707 0654053307
449 311 0653051108	621 427 0654052108	829 569 0654052208	1.180 809 0654053308
505 350 0653051109	698 480 0654052109	933 640 0654052209	1.328 910 0654053309
561 389 0653051110	776 534 0654052110	1.036 711 0654052210	1.476 1.011 0654053310
673 467 0653051112	932 641 0654052112	1.244 854 0654052212	1.771 1.213 0654053312
785 544 0653051114	1.087 747 0654052114	1.451 996 0654052214	2.066 1.415 0654053314
898 622 0653051116	1.242 854 0654052116	1.658 1.138 0654052216	2.361 1.617 0654053316
1.010 700 0653051118	1.397 960 0654052118	1.865 1.280 0654052218	2.656 1.819 0654053318
1.123 778 0653051120	1.552 1.067 0654052120	2.073 1.423 0654052220	2.951 2.022 0654053320

Core assortment (Stelrad white 9016) available ex factory within 10 days.  
Core assortment is subject to change, please refer to [www.stelrad.eu](http://www.stelrad.eu) for the latest information.  
Delivery time depends on the model, please refer to your distributor.

# PLANAR STYLE 8

On the label:  
8-CONNECTIONS DECO

Art. 0654 09 22 04

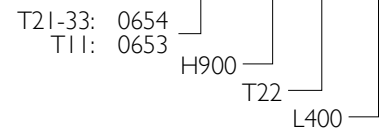

Height	600			
Type	11	21	22	33
W/m 75/65/20°C	870	1.196	1.601	2.280
<b>400</b>	262 181 0653061104	357 245 0654062104	477 327 0654062204	679 464 0654063304
<b>500</b>	327 227 0653061105	447 307 0654062105	597 409 0654062205	849 580 0654063305
<b>600</b>	393 272 0653061106	536 368 0654062106	717 491 0654062206	1.018 696 0654063306
<b>700</b>	458 317 0653061107	625 430 0654062107	836 573 0654062207	1.188 812 0654063307
<b>800</b>	523 363 0653061108	715 491 0654062108	955 655 0654062208	1.358 928 0654063308
<b>900</b>	589 408 0653061109	804 552 0654062109	1.075 736 0654062209	1.528 1.044 0654063309
<b>1000</b>	654 453 0653061110	894 614 0654062110	1.194 818 0654062210	1.697 1.160 0654063310
<b>1200</b>	785 544 0653061112	1.072 736 0654062112	1.433 982 0654062212	2.037 1.392 0654063312
<b>1400</b>	916 634 0653061114	1.251 859 0654062114	1.671 1.145 0654062214	2.376 1.625 0654063314
<b>1600</b>	1.047 725 0653061116	1.430 982 0654062116	1.911 1.309 0654062216	2.716 1.857 0654063316
<b>1800</b>	1.178 816 0653061118	1.609 1.105 0654062118	2.149 1.473 0654062218	3.055 2.089 0654063318
<b>2000</b>	1.309 906 0653061120	1.787 1.227 0654062120	2.388 1.636 0654062220	3.395 2.321 0654063320

700			
11	21	22	33
987	1.350	1.796	2.553
297 206 0653071104	403 277 0654072104	535 366 0654072204	760 519 0654073304
371 257 0653071105	504 346 0654072105	669 458 0654072205	949 648 0654073305
445 308 0653071106	605 415 0654072106	803 550 0654072206	1.140 778 0654073306
519 360 0653071107	705 484 0654072107	937 641 0654072207	1.329 908 0654073307
594 411 0653071108	806 553 0654072108	1.071 733 0654072208	1.519 1.037 0654073308
668 462 0653071109	907 622 0654072109	1.204 824 0654072209	1.710 1.167 0654073309
742 514 0653071110	1.008 691 0654072110	1.338 916 0654072210	1.899 1.297 0654073310
890 616 0653071112	1.209 830 0654072112	1.606 1.099 0654072212	2.279 1.557 0654073312
1.039 719 0653071114	1.411 968 0654072114	1.874 1.282 0654072214	2.659 1.816 0654073314
1.187 822 0653071116	1.613 1.106 0654072116	2.142 1.466 0654072216	3.039 2.075 0654073316
1.336 925 0653071118	1.814 1.245 0654072118	2.409 1.649 0654072218	3.418 2.334 0654073318
1.484 1.027 0653071120	2.016 1.383 0654072120	2.677 1.832 0654072220	3.798 2.594 0654073320

900			
11	21	22	33
1.200	1.649	2.132	3.022
361 250 0653091104	492 337 0654092104	635 434 0654092204	898 612 0654093304
451 312 0653091105	614 421 0654092105	793 542 0654092205	1.122 765 0654093305
541 375 0653091106	737 505 0654092106	952 650 0654092206	1.347 918 0654093306
632 437 0653091107	860 589 0654092107	1.110 759 0654092207	1.571 1.071 0654093307
722 500 0653091108	983 673 0654092108	1.270 867 0654092208	1.796 1.224 0654093308
812 562 0653091109	1.106 758 0654092109	1.428 976 0654092209	2.020 1.377 0654093309
902 625 0653091110	1.229 842 0654092110	1.587 1.084 0654092210	2.245 1.530 0654093310
1.083 750 0653091112	1.475 1.011 0654092112	1.904 1.300 0654092212	2.693 1.836 0654093312
1.263 875 0653091114	1.722 1.179 0654092114	2.221 1.518 0654092214	3.143 2.142 0654093314
1.444 1.000 0653091116	1.967 1.347 0654092116	2.538 1.734 0654092216	3.591 2.448 0654093316
1.624 1.125 0653091118	2.213 1.515 0654092118	2.856 1.951 0654092218	4.041 2.754 0654093318
1.805 1.250 0653091120	2.459 1.684 0654092120	3.173 2.168 0654092220	4.489 3.060 0654093320

# CONNECTION POSSIBILITIES

Types 11 / 21 / 22 / 33

Radiator with insert on the right hand side

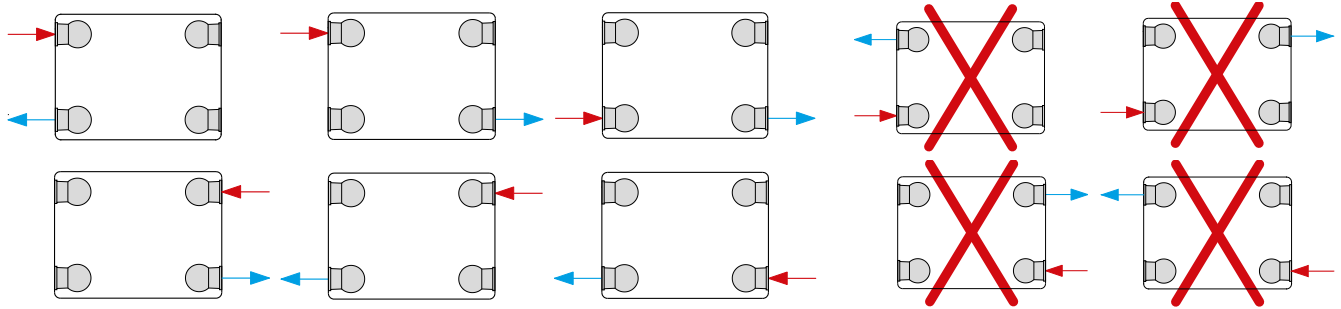
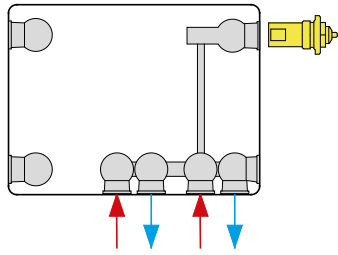

When connecting as a compact radiator the valve insert has to be removed.

# MOUNTING DIMENSIONS

Types 11 / 21 / 22 / 33

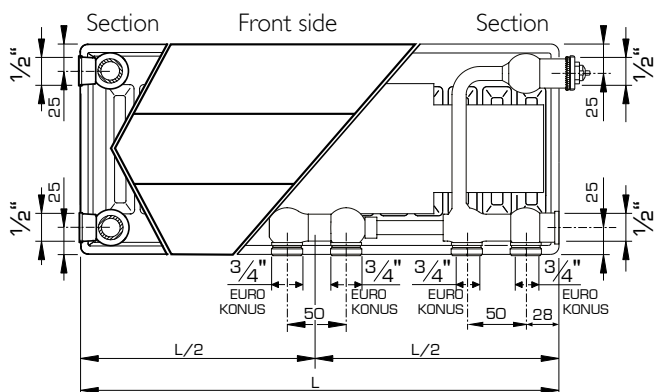

# J-BRACKETS (TYPE MONCLAC VDI 6036)

Type 11

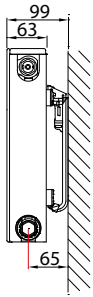

Type 21

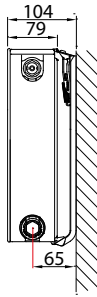

Type 22

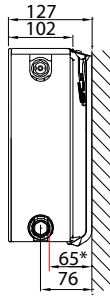

Type 33

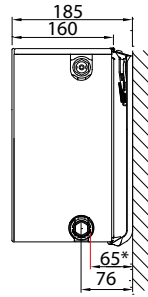

\* centre connection only

Type 11		Art. N°.		Height mm	Types 21-33			Art. N°.		Height mm	
J-bracket VDI 6036 Class 3	x	y	2 pcs.		3 pcs.	J-bracket VDI 6036 Class 3	x	y	2 pcs.		3 pcs.
	/	140	R509203	R509303	300		64	190	R510203	R510303	300
	103	240	R509204	R509304	400		64	290	R510204	R510304	400
	103	340	R509205	R509305	500		64	390	R510205	R510305	500
	103	440	R509206	R509306	600		64	490	R510206	R510306	600
	103	540	R509207	R509307	700		64	590	R510207	R510307	700
	103	740	R509209	R509309	900		64	790	R510209	R510309	900

For lengths from 1800 mm: 3 brackets needed.

## LUG POSITIONS TYPE 11

Type 11

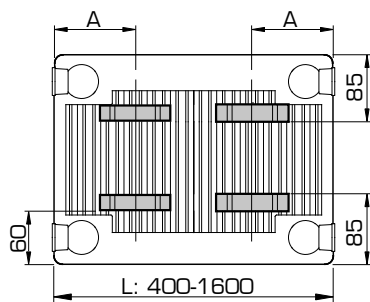

L	A
400	117
500-1600	150

Type 11

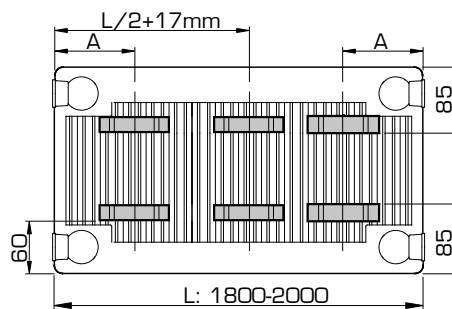

L	A
1800-2000	150



Austria • Belarus • Belgium • Cyprus • Czech Republic • Estonia • France • Germany • Greece • Iceland • Ireland • Lithuania  
Luxemburg • Norway • Poland • Portugal • Slovenia • Spain • Sweden • The Netherlands • Tunisia • Ukraine • United Kingdom

**NEDERLANDS**

Caradon Stelrad B.V. | Kathagen 30 | 6361 HG Nuth | T. +31 455 65 62 62

**WWW.STELRAD.EU**

